

Инструкция по сборке

Карлос

Книжный шкаф - 045

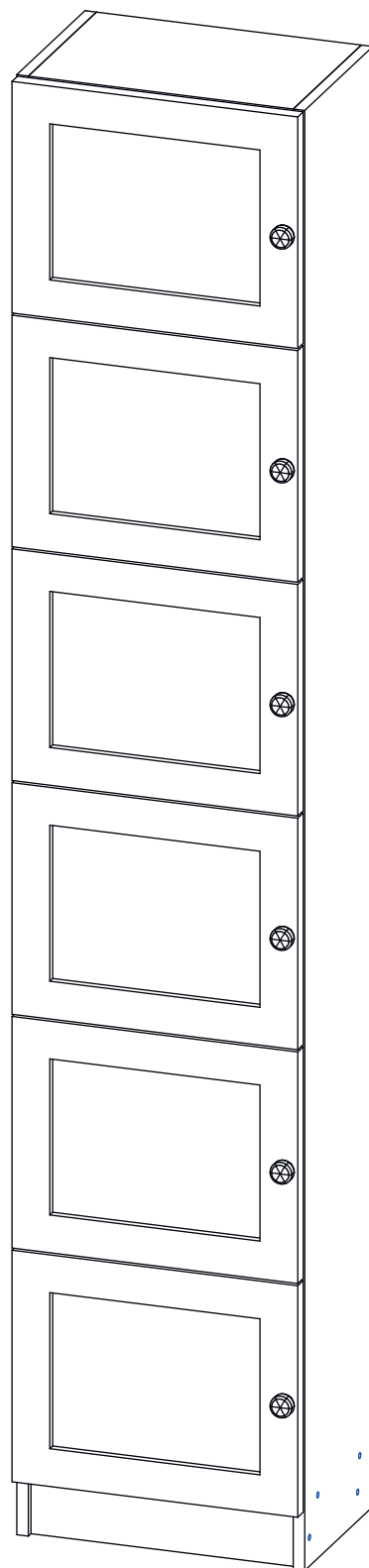



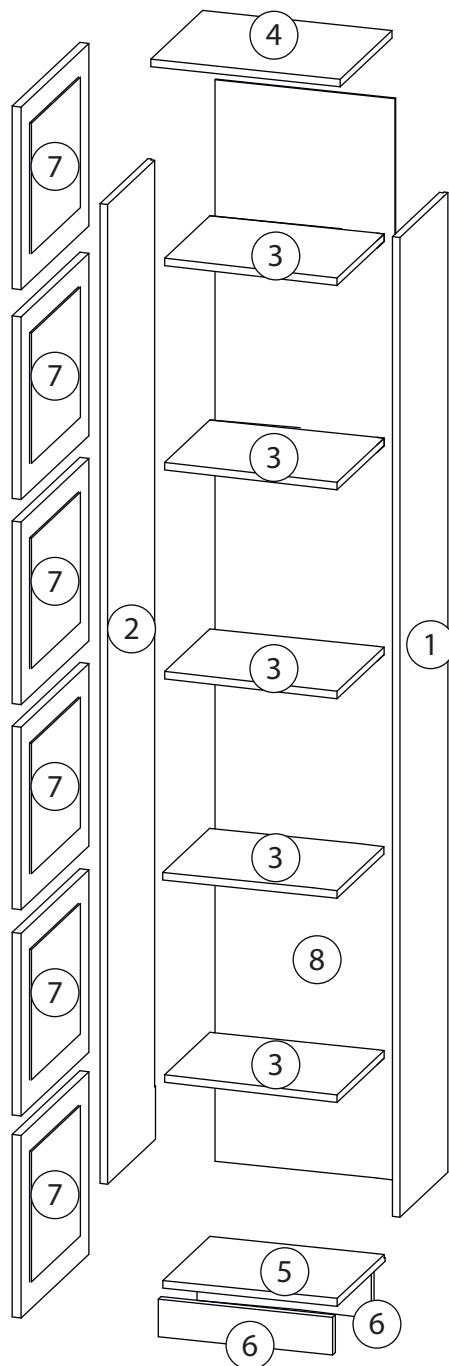

Детали

Поз.	Наименование	Кол-во	Длина	Ширина
1	Правый бок	1	2030	260
2	Левый бок	1	2030	260
3	Горизонтальная	5	368	260
4	Горизонтальная	1	368	260
5	Горизонтальная	1	368	260
6	Цоколь	2	80	368
7	Фасад	6	322	397
8	Задняя стенка	1	1947	397

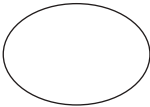
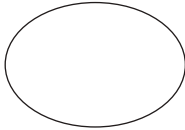

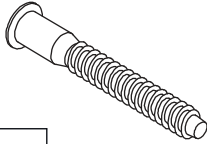
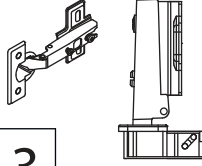
Фурнитура

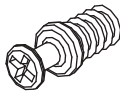
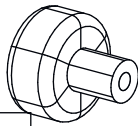
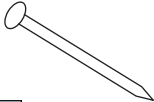
				
9	10	11	12	13
<u>Заглушка</u> <u>Ø13</u>	<u>Заглушка</u> <u>Ø17-20</u>	<u>Евровинт 6,3x13</u>	<u>Евровинт 7x50</u>	<u>Петля накладная</u>
				
14	15	16	17	18
<u>Саморез 3,5x16</u>	<u>Стяжка VB35</u>	<u>Винт для стяжки</u> <u>VB35</u>	<u>Ручка кнопка</u>	<u>Гвоздь 1,6x25</u>

1

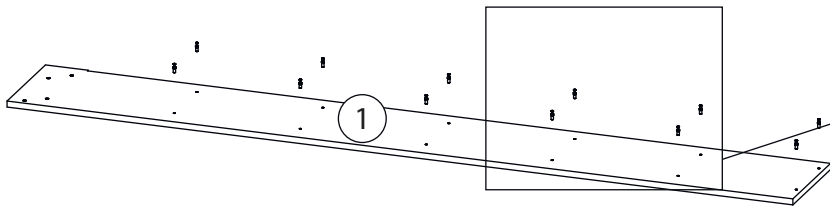

Бок левый (2)
собирается зеркально

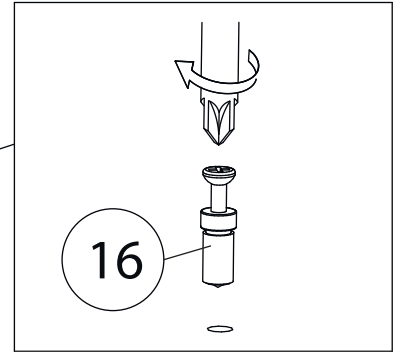

2

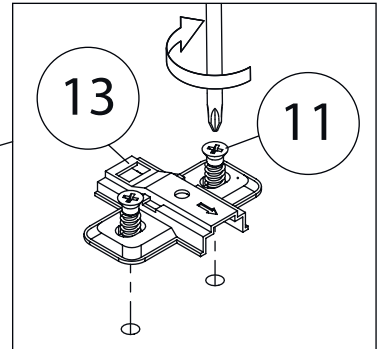
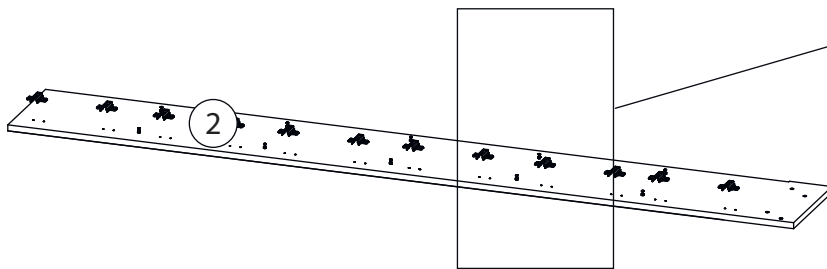

3

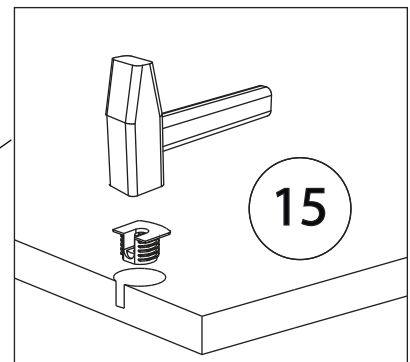
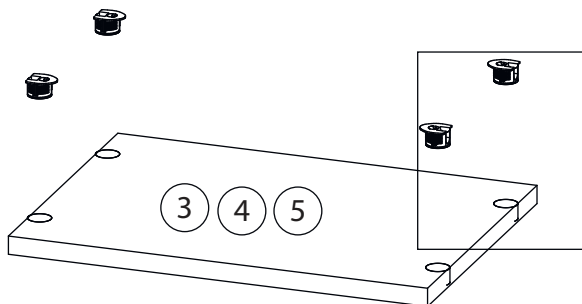

4

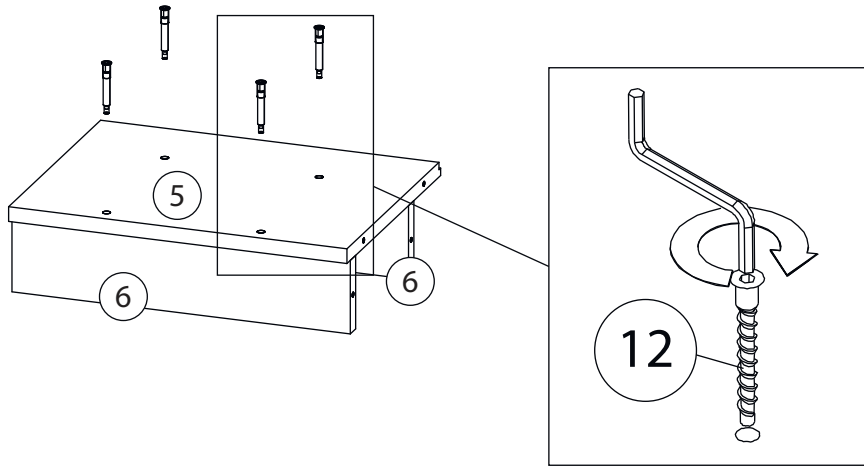

5

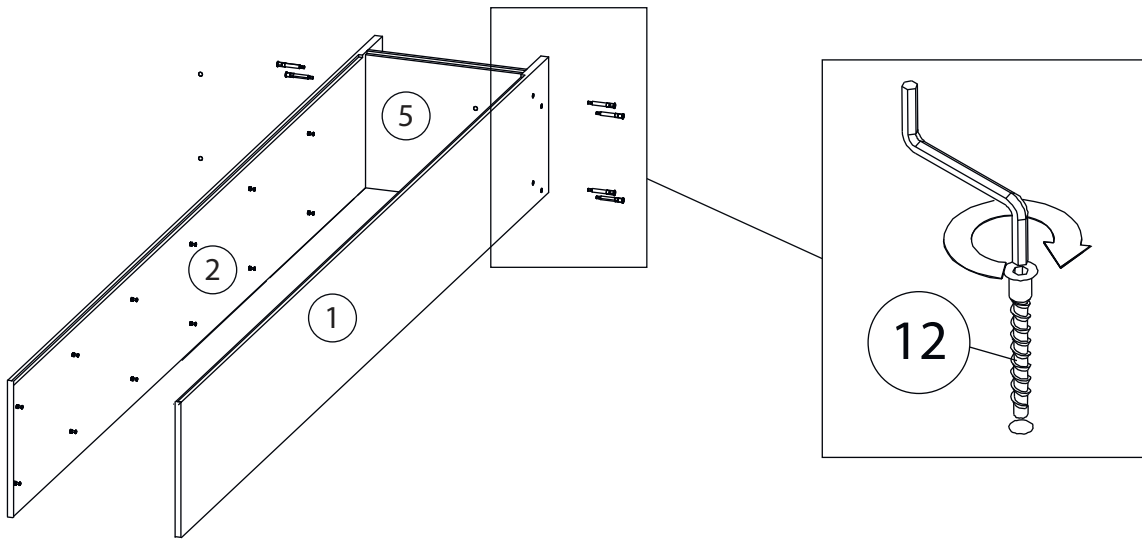

6

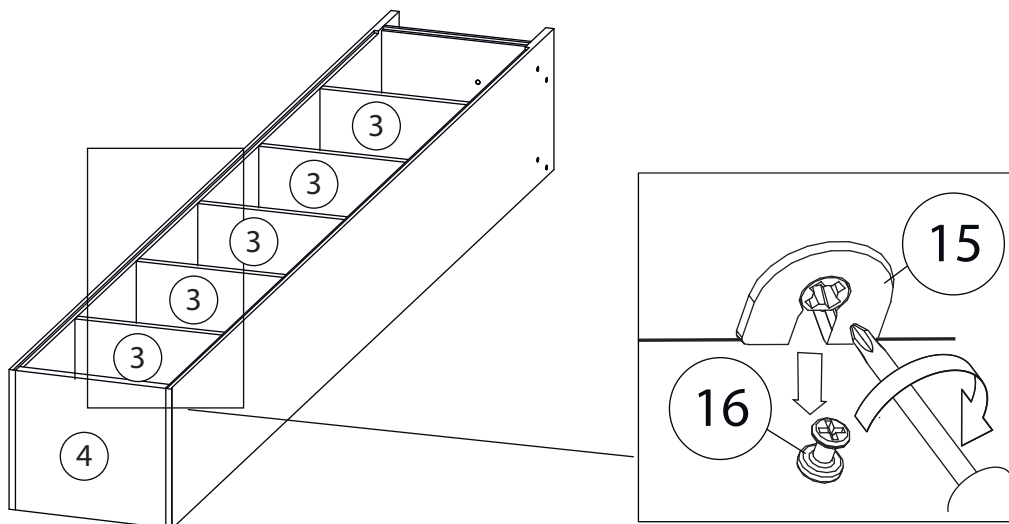

7

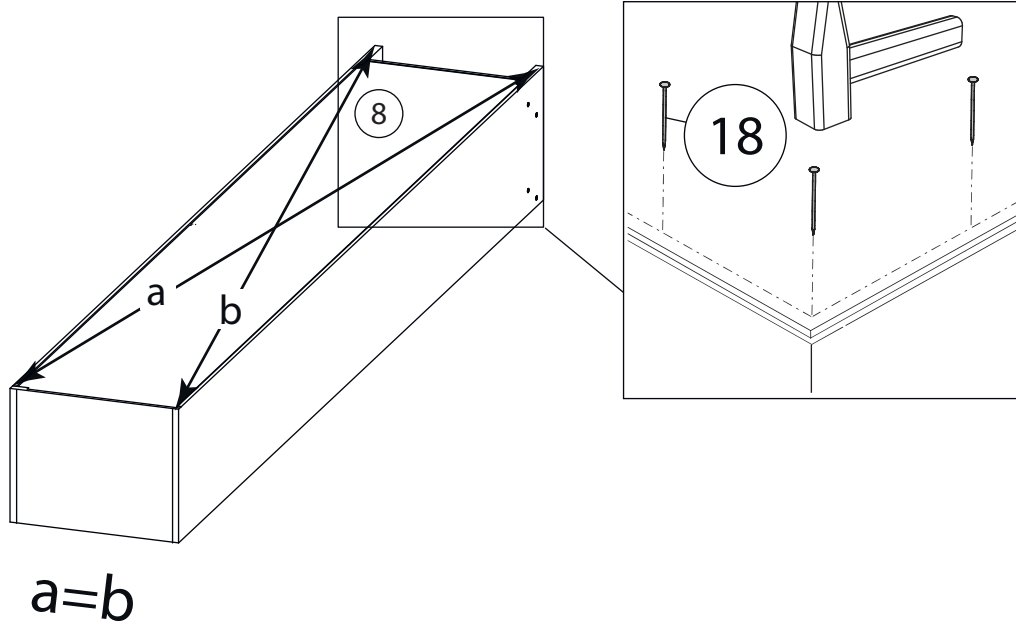

8

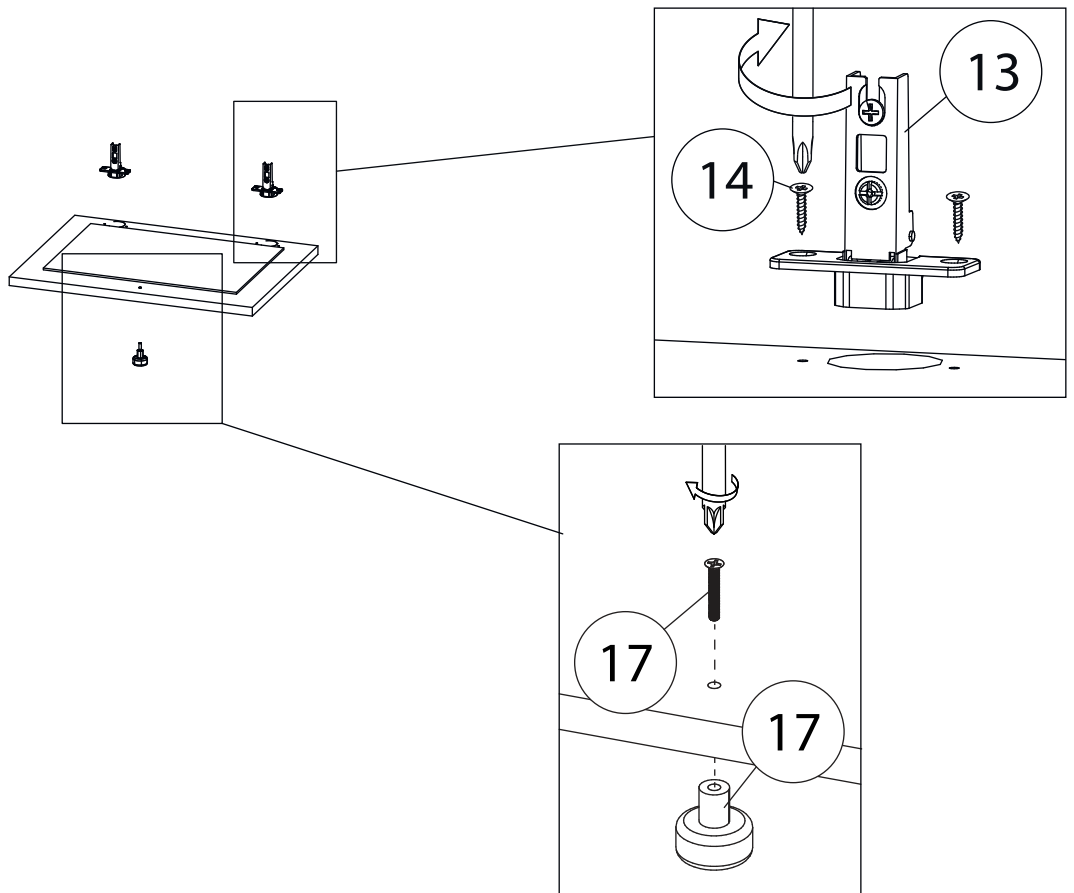

9

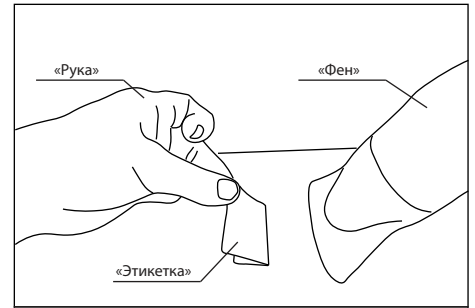
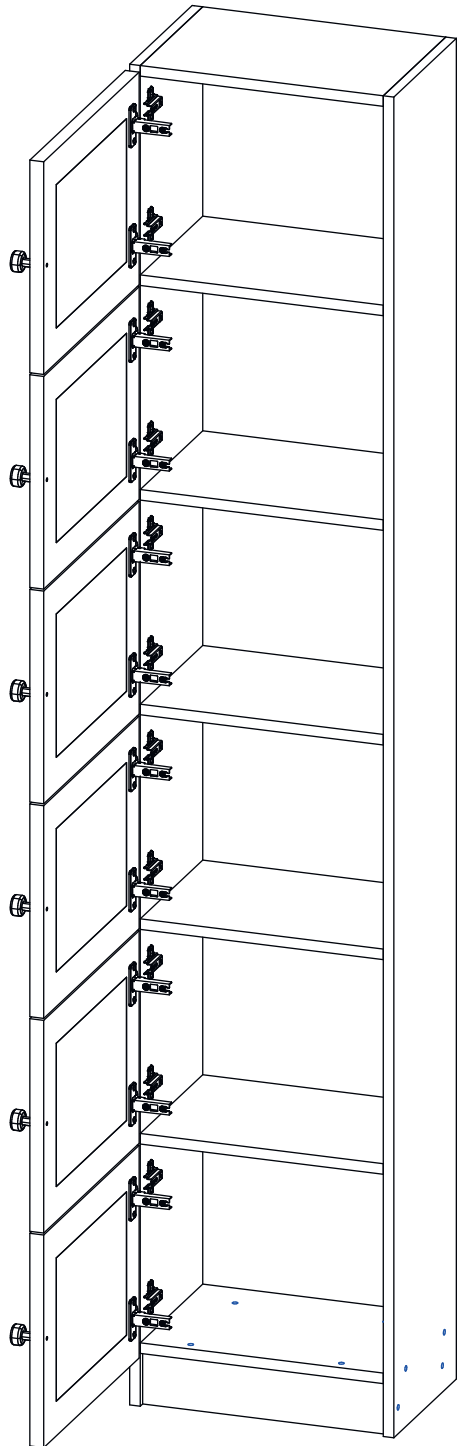

Удалить с детали этикетки со штрихкодом при помощи фена.

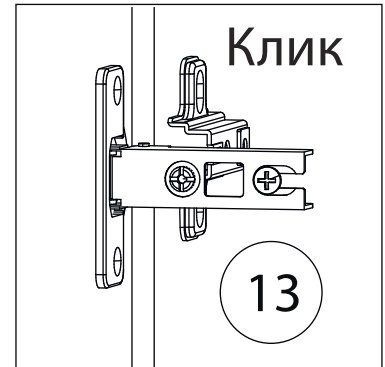

Заклеить технические отверстия заглушками.

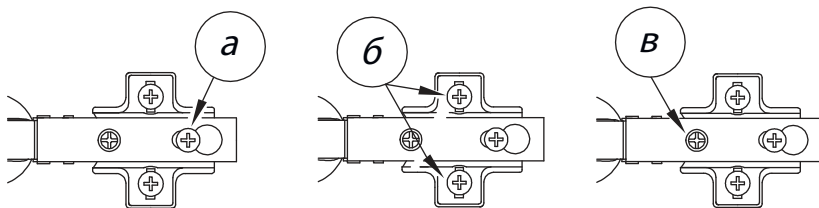

Регулировка петель

а - регулировка расстояния между дверью и корпусом
б - регулировка положения двери по-вертикали
в - регулировка положения двери по-горизонтали